

Winding Materials:	Max. Temp. Range
Stainless Steel 304	760°C
Stainless Steel 316L	760°C
Filler Materials:	
Graphite	523°C
PTFE	260°C
Guide Ring Materials:	
Carbon Steel	538°C
Inner Ring Materials:	
Stainless Steel 304	760°C
Stainless Steel 316	760°C

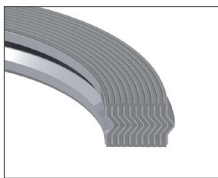

Winding

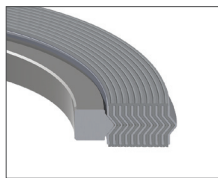

Winding w/ Inner Ring

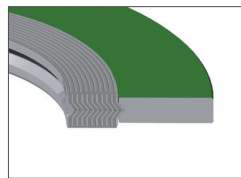

Winding w/ Centering Ring

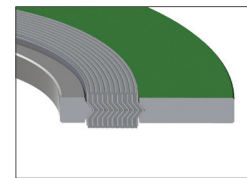

Winding w/ Inner & Centering Ring

Product Description:

Spiral wound gaskets are designed for ASME B16.20 and ANSI B16.5 flanges. Spiral wound gaskets are available for classes 150 to 2500. Custom filler, winding strip, guide ring and inner ring materials are available upon request.

Part Numbers:

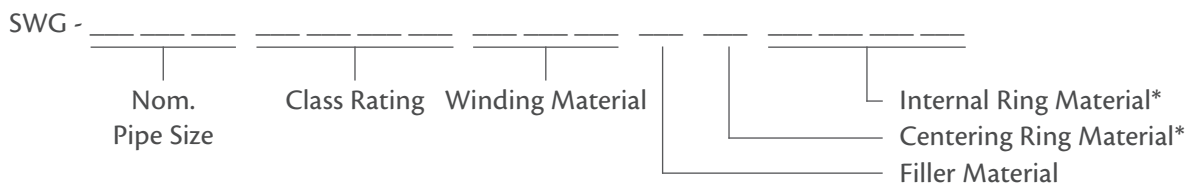

Example: SWG 260 150 316 G C I - Spiral Wound Gasket - 26" Nominal Pipe, 150#, Stainless Steel 316 Winding Material, Graphite Filler, Carbon Steel Centering Ring, Stainless Steel 316 Inner Ring

* If there is no internal ring or if there is no innternal ring or centering ring there is no material indicated



Selecting Your Spiral Wound Gasket

Applications

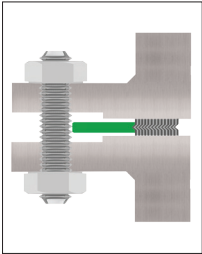
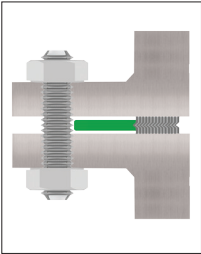
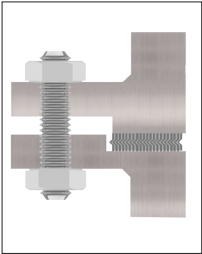
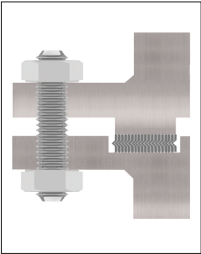
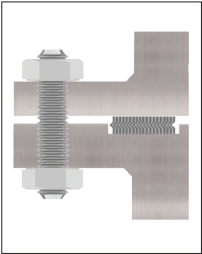
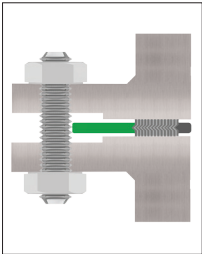
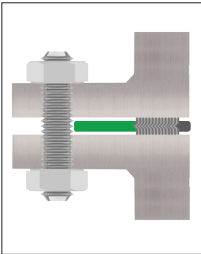
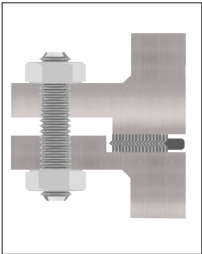
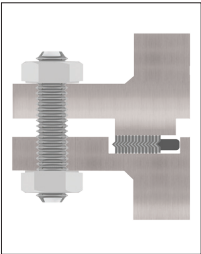
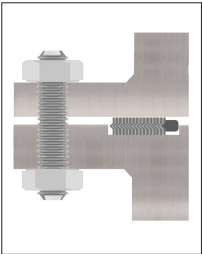
	<i>Raised Face</i>	<i>Flat Face</i>	<i>Male & Female</i>	<i>Tongue & Groove</i>	<i>Flat Face to Recessed</i>
Service:					
General Duty					
	Winding w/ Centering Ring	Winding w/ Centering Ring	Winding	Winding	Winding
High Pressure High Temperature Fluctuating Pressures SWG w/ PTFE Fillers					
	Winding w/ Inner & Centering Ring	Winding w/ Inner & Centering Ring	Winding w/ Inner Ring	Winding w/ Inner Ring	Winding w/ Inner Ring

Colour Coding

Centering rings are painted in accordance to ASME B16.20 . The solid colour on the centering ring indicates the metallic winding material. The stripped colour indicates the non-metallic filler used between the metal winding.

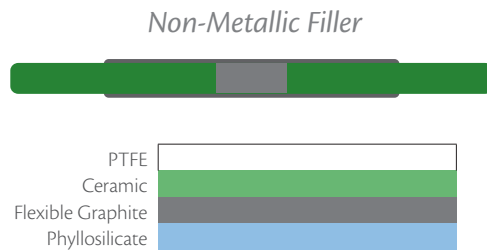

Winding Material

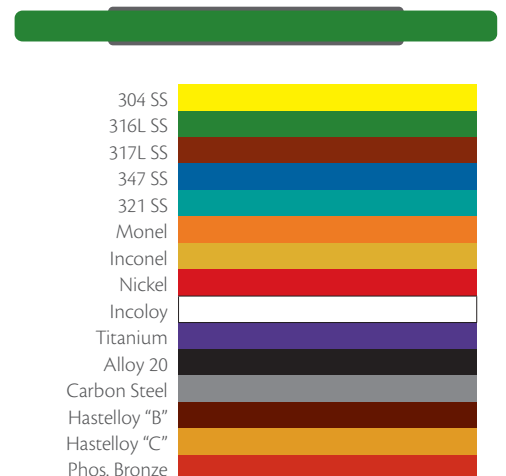

Winding Pipes Under 24"

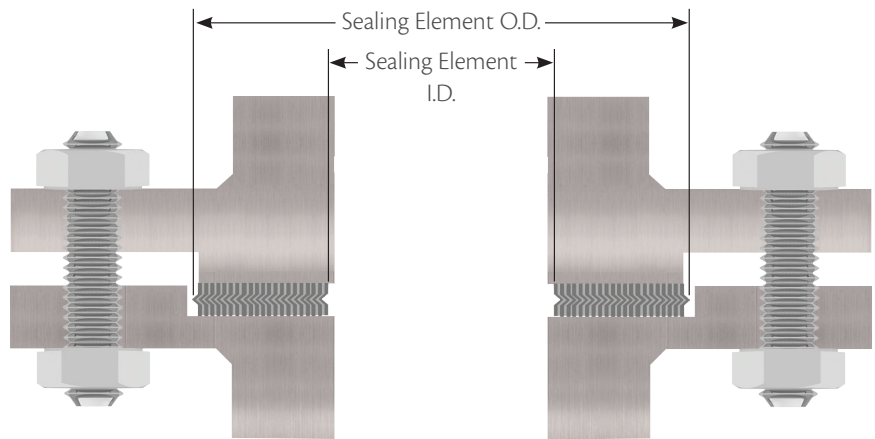
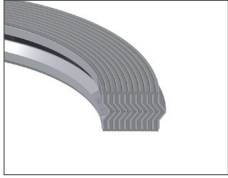

ASME B16.5 & BS 1560 Flanges

Nom. Pipe Size	Male and Female				Large Tongue Groove		Small Tongue and Groove	
	Sealing Element 150-1500		Sealing Element Class 2500		Sealing Element Class 150-2500		Sealing Element 150-2500	
	I.D.	O.D.	I.D.	O.D.	I.D.	O.D.	I.D.	O.D.
1/4	1/2	1	-	-	1/2	1	-	-
1/2	1	1-3/8	13/16	1-3/8	1	1-3/8	1	1-3/8
3/4	1-5/16	1-11/16	1-1/16	1-11/16	1-5/16	1-11/16	1-5/16	1-11/16
1	1-1/2	2	1-1/4	2	1-1/2	2	1-1/2	1-7/8
1- 1/4	1-7/8	2-1/2	1-5/8	2-1/2	1-7/8	2-1/2	1-7/8	2-1/4
1- 1/2	2-1/8	2-7/8	1-7/8	2-7/8	2-1/8	2-7/8	2-1/8	2-1/2
2	2-7/8	3-5/8	2-3/8	3-5/8	2-7/8	3-5/8	2-7/8	3-1/4
2- 1/2	3-3/8	4-1/8	3	4-1/8	3-3/8	4-1/8	3-3/8	3-3/4
3	4-1/4	5	3-3/4	5	4-1/8	5	4-1/4	4-5/8
3- 1/2	4-3/4	5-1/2	-	-	4-3/4	5-1/2	4-3/4	5-1/8
4	5-3/16	6-3/16	4-3/4	6-3/16	5-3/16	6-3/16	5-3/16	5-11/16
4- 1/2	5-11/16	6-3/4	-	-	5-11/16	6-3/4	-	-
5	6-5/16	7-5/16	5-3/4	7-5/16	6-5/16	7-5/16	6-5/16	6-13/16
6	7-1/2	8-1/2	6-3/4	8-1/2	7-1/2	8-1/2	7-1/2	8
8	9-3/8	10-5/8	8-3/4	10-5/8	9-3/8	10-5/8	9-3/8	10
10	11-1/4	12-3/4	10-3/4	12-3/4	11-1/4	12-3/4	11-1/4	12
12	13-1/2	15	13	15	13-1/2	15	13-1/2	14-1/4
14	14-3/4	16-1/4	-	-	14-3/4	16- 1/4	14-3/4	15-1/2
16	17	18-1/2	-	-	17	18- 1/2	16-3/4	17-5/8
18	19-1/4	21	-	-	19-1/4	21	19-1/4	20-1/8
20	21	23	-	-	21	23	21	22
24	25-1/4	27-1/4	-	-	25-1/4	27- 1/4	25-1/4	26-1/4

Large Tongue & Groove Flanges:

- 1/2 size in Class 150, 300, 400, 600, 900, 1500 and 2500 are interchangeable

Male & Female and Large Tongue & Groove Flanges:

- Class 300, 400, 600 gaskets are interchangeable within their size category
- Class 900 and 1500 gaskets are interchangeable within their size category
- 1/4 size in 150 class are interchangeable

Small Tongue and Groove Flanges:

- Classes 300 thru 2500 are interchangeable within their specific size category
- 3/4 size are interchangeable with Large Male & Female and Large Tongue and Groove gaskets within their specific pressure rating
- 1/2 size are interchangeable within Large Male & Female and Large Tongue and Groove gaskets within their specific pressure rating



Spiral Wound Gaskets

Winding w/ Centering Ring Pipes Under 24"

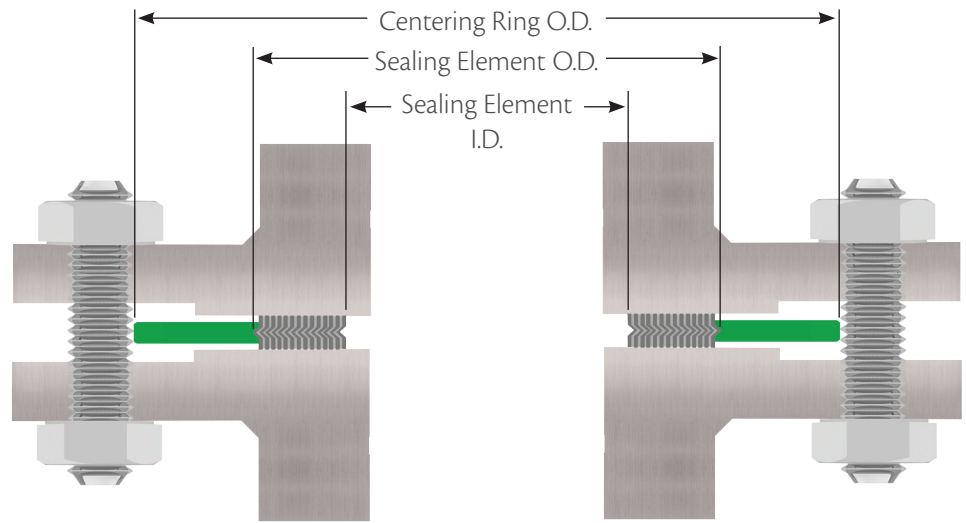
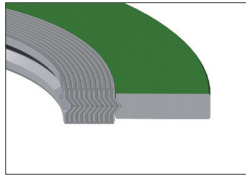

ASME B16.20 for ASME B16.5 Flanges

Nom. Pipe Size	Inside Diameter of Sealing Element							Outside Diameter of Sealing Element		Outer Diameter of Centering Ring						
	150	300	400	600	900	1500	2500	150,300 400,600	900,1500 2500	150	300	400	600	900	1500	2500
1/4	1/2	1/2	1/2	1/2	-	-	-	7/8	-	1-3/4	1-3/4	1-3/4	1-3/4	-	-	-
1/2	3/4	3/4	3/4	3/4	3/4	3/4	3/4	1-1/4	1-1/4	1-7/8	2-1/8	2-1/8	2-1/8	2-1/2	2-1/2	2-3/4
3/4	1	1	1	1	1	1	1	1-9/16	1-9/16	2-1/4	2-5/8	2-5/8	2-5/8	2-3/4	2-3/4	3
1	1-1/4	1-1/4	1-1/4	1-1/4	1-1/4	1-1/4	1-1/4	1-7/8	1-7/8	2-5/8	2-7/8	2-7/8	2-7/8	3-1/8	3-1/8	3-3/8
1-1/4	1-7/8	1-7/8	1-7/8	1-7/8	1-9/16	1-9/16	1-9/16	2-3/8	2-3/8	3	3-1/4	3-1/4	3-1/4	3-1/2	3-1/2	4-1/8
1-1/2	2-1/8	2-1/8	2-1/8	2-1/8	1-7/8	1-7/8	1-7/8	2-3/4	2-3/4	3-3/8	3-3/4	3-3/4	3-3/4	3-7/8	3-7/8	4-5/8
2	2-3/4	2-3/4	2-3/4	2-3/4	2-5/16	2-5/16	2-5/16	3-3/8	3-3/8	4-1/8	4-3/8	4-3/8	4-3/8	5-5/8	5-5/8	5-3/4
2-1/2	3-1/4	3-1/4	3-1/4	3-1/4	2-3/4	2-3/4	2-3/4	3-7/8	3-7/8	4-7/8	5-1/8	5-1/8	5-1/8	6-1/2	6-1/2	6-5/8
3	4	4	4	4	3-3/4	3-5/8	3-5/8	4-3/4	4-3/4	5-3/8	5-7/8	5-7/8	5-7/8	6-5/8	6-7/8	7-3/4
3-1/2	4-1/2	4-1/2	4-1/8	4-1/8	4-1/8	4-1/8	-	5-1/4	5-1/4	6-3/8	6-1/2	6-3/8	6-3/8	7-1/2	7-3/8	-
4	5	5	4-3/4	4-3/4	4-3/4	4-5/8	4-5/8	5-7/8	5-7/8	6-7/8	7-1/8	7	7-5/8	8-1/8	8-1/4	9-1/4
4-1/2	5-1/2	5-1/2	5-5/16	5-5/16	5-5/16	5-5/16	-	6-1/2	6-1/2	7	7-3/4	7-5/8	8-1/4	9-3/8	9-1/8	-
5	6-1/8	6-1/8	5-13/16	5-13/16	5-13/16	5-5/8	5-5/8	7	7	7-3/4	8-1/2	8-3/8	9-1/2	9-3/4	10	11
6	7-3/16	7-3/16	6-7/8	6-7/8	6-7/8	6-3/4	6-3/4	8-1/4	8-1/4	8-3/4	9-7/8	9-3/4	10-1/2	11-3/8	11-1/8	12-1/2
8	9-3/16	9-3/16	8-7/8	8-7/8	8-3/4	8-1/2	8-1/2	10-3/8	10-1/8	11	12-1/8	12	12-5/8	14-1/8	13-7/8	15-1/4
10	11-5/16	11-5/16	10-13/16	10-13/16	10-7/8	10-1/2	10-5/8	12-1/2	12-1/4	13-3/8	14-1/4	14-1/8	15-3/4	17-1/8	17-1/8	18-3/4
12	13-3/8	13-3/8	12-7/8	12-7/8	12-3/4	12-3/4	12-1/2	14-3/4	14-1/2	16-1/8	16-5/8	16-1/2	18	19-5/8	20-1/2	21-5/8
14	14-5/8	14-5/8	14-1/4	14-1/4	14	14-1/4	-	16	15-3/4	17-3/4	19-1/8	19	19-3/8	20-1/2	22-3/4	-
16	16-5/8	16-5/8	16-1/4	16-1/4	16-1/4	16	-	18-1/4	18	20-1/4	21-1/4	21-1/8	22-1/4	22-5/8	25-1/4	-
18	18-11/16	18-11/16	18-1/2	18-1/2	18-1/4	18-1/4	-	20-3/4	20-1/2	21-5/8	23-1/2	23-3/8	24-1/8	25-1/8	27-3/4	-
20	20-11/16	20-11/16	20-1/2	20-1/2	20-1/2	20-1/4	-	22-3/4	22-1/2	23-7/8	25-3/4	25-1/2	26-7/8	27-1/2	29-3/4	-
24	24-3/4	24-3/4	24-3/4	24-3/4	24-3/4	24-1/4	-	27	26-3/4	28-1/4	30-1/2	30-1/4	31-1/8	33	35-1/2	-



Inner Ring Dimensions Pipes Under 24"

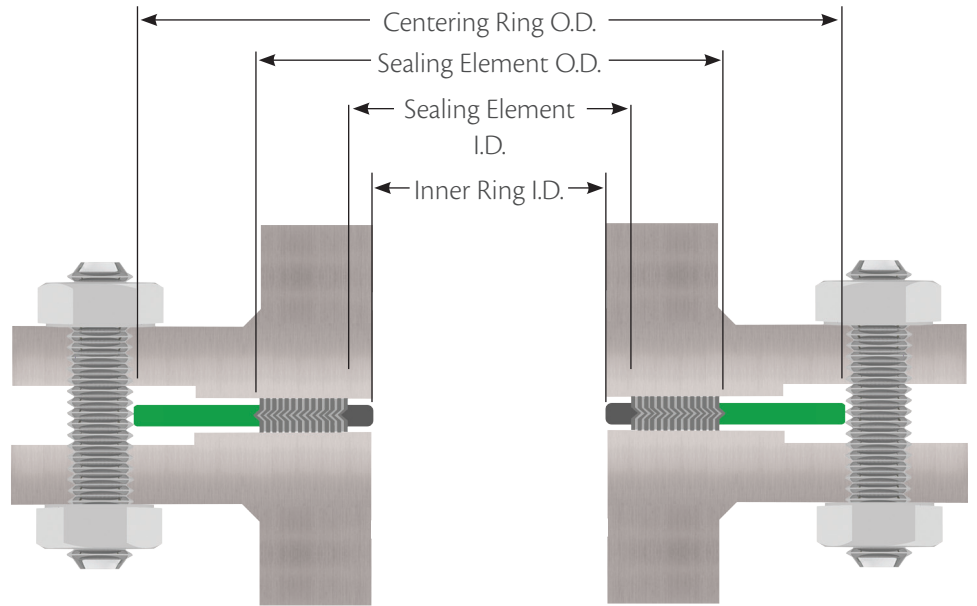
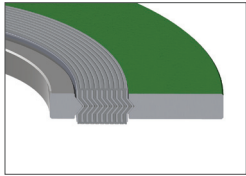

Standard inside diameter of inner rings

Nom. Pipe Size	Pressure Class						
	150	300	400	600	900	1500	2500
1/2	0.56	0.56	0.56	0.56	0.56	0.56	0.56
3/4	0.81	0.81	0.81	0.81	0.81	0.81	0.81
1	1.06	1.06	1.06	1.06	1.06	1.06	1.06
1-1/4	1.50	1.50	1.50	1.50	1.31	1.31	1.31
1-1/2	1.75	1.75	1.75	1.75	1.63	1.63	1.63
2	2.19	2.19	2.19	2.19	2.06	2.06	2.06
2-1/2	2.62	2.62	2.62	2.62	2.50	2.50	2.50
3	3.19	3.19	3.19	3.19	3.10	3.10	3.10
4	4.19	4.19	4.04	4.04	4.04	3.85	3.85
5	5.19	5.19	5.05	5.05	5.05	4.90	4.90
6	6.19	6.19	6.10	6.10	6.10	5.80	5.80
8	8.50	8.50	8.10	8.10	7.75	7.75	7.75
10	10.56	10.56	10.05	10.05	9.69	9.69	9.69
12	12.50	12.50	12.10	12.10	11.50	11.50	11.50
14	13.75	13.75	13.50	13.50	12.63	12.63	-
16	15.75	15.75	15.35	15.35	14.75	14.50	-
18	17.69	17.69	17.25	17.25	16.75	16.75	-
20	19.69	19.69	19.25	19.25	19.00	18.75	-
24	23.75	23.75	23.25	23.25	23.25	22.75	-

Spiral Wound Gaskets

Series B Flanges 26" and Over

Nom. Pipe Size	Class 75			Class 150				Class 300			
	Sealing Element I.D.	Sealing Element O.D.	Centering Ring O.D.	Inner Ring I.D.	Sealing Element I.D.	Sealing Element O.D.	Centering Ring O.D.	Inner Ring I.D.	Sealing Element I.D.	Sealing Element O.D.	Centering Ring O.D.
26	26-1/4	27	27-7/8	25-3/4	26-1/2	27-1/2	28-9/16	25-3/4	26-1/2	28	30-3/8
28	28-1/4	29-1/8	29-7/8	27-3/4	28-1/2	29-1/2	30-9/16	27-3/4	28-1/2	30	32-1/2
30	30-1/4	31-1/8	31-7/8	29-3/4	30-1/2	31-1/2	32-9/16	29-3/4	30-1/2	32	34-7/8
32	32-1/4	33-1/8	33-7/8	31-3/4	32-1/2	33-1/2	34-11/16	31-3/4	32-1/2	34	37
34	34-1/4	35-1/8	35-7/8	33-3/4	34-1/2	35-3/4	36-13/16	33-3/4	34-1/2	36	39-1/8
36	36-1/4	37-1/4	38-5/16	35-3/4	36-1/2	37-3/4	38-7/8	35-3/4	36-1/2	38	41-1/4
38	-	-	-	37-3/4	38-3/8	39-3/4	41-1/8	38-1/4	39-3/4	41-1/4	43-1/4
40	-	-	-	39-3/4	40-1/4	41-7/8	43-1/8	40-1/4	41-3/4	43-1/4	45-1/4
42	42-1/4	43-1/4	44-5/16	41-3/4	42-1/2	43-7/8	45-1/8	42-3/4	43-3/4	45-1/4	47-1/4
44	-	-	-	43-3/4	44-1/4	45-7/8	47-1/8	44-1/4	45-3/4	47-1/4	49-1/4
46	-	-	-	45-3/4	46-1/2	48-3/16	49-7/16	46-3/8	47-7/8	49-3/8	51-7/8
48	48-3/8	49-1/2	50-1/2	47-3/4	48-1/2	50	51-7/16	48-1/2	49-3/4	51-5/8	53-7/8
50	-	-	-	49-3/4	50-1/2	52-3/16	53-7/16	49-7/8	51-7/8	53-3/8	55-7/8
52	-	-	-	51-3/4	52-1/2	54-3/16	55-7/16	51-7/8	53-7/8	55-3/8	57-7/8
54	54-3/8	55-5/8	56-5/8	53-3/4	54-1/2	56	57-5/8	53-3/4	55-1/4	57-1/4	60-1/4
56	-	-	-	56	56-7/8	58-3/16	59-5/8	56-1/4	58-1/4	60	62-3/4
58	-	-	-	58-3/16	59-1/16	60-3/16	62-3/16	58-7/16	60-7/16	61-15/16	65-3/16
60	60-1/2	61-3/4	62-7/8	60-7/16	61-5/16	62-7/16	64-3/16	61-5/16	62-9/16	64-3/16	67-3/16

Nom. Pipe Size	Class 400				Class 600				Class 900			
	Inner Ring I.D.	Sealing Element I.D.	Sealing Element O.D.	Centering Ring O.D.	Inner Ring I.D.	Sealing Element I.D.	Sealing Element O.D.	Centering Ring O.D.	Inner Ring I.D.	Sealing Element I.D.	Sealing Element O.D.	Centering Ring O.D.
26	25-3/4	26-1/4	27-1/2	29-3/8	25-3/8	26-1/8	28-1/8	30-1/8	26-1/4	27-1/4	29-1/2	33
28	27-5/8	28-1/8	29-1/2	31-1/2	27	27-3/4	29-3/4	32-1/4	28-1/4	29-1/4	31-1/2	35-1/2
30	29-5/8	30-1/8	31-3/4	33-3/4	29-5/8	30-5/8	32-5/8	34-5/8	30-3/4	31-3/4	33-3/4	37-3/4
32	31-1/2	32	33-7/8	35-7/8	31-1/4	32-3/4	34-3/4	36-3/4	33	34	36	40
34	33-1/2	34-1/8	35-7/8	37-7/8	33-1/2	35	37	39-1/4	35-1/4	36-1/4	38-1/4	42-1/4
36	35-3/8	36-1/8	38	40-1/4	35-1/2	37	39	41-1/4	36-1/4	37-1/4	39-1/4	44-1/4
38	37-1/2	38-1/4	40-1/4	42-1/4	37-1/2	39	41	43-1/2	39-3/4	40-3/4	42-3/4	47-1/4
40	39-3/8	40-3/8	42-3/8	44-3/8	39-3/4	41-1/4	43-1/4	45-1/2	41-3/4	43-1/4	45-1/4	49-1/4
42	41-3/8	42-3/8	44-3/8	46-3/8	42	43-1/2	45-1/2	48	43-3/4	45-1/4	47-1/4	51-1/4
44	43-1/2	44-1/2	46-1/2	48-1/2	43-3/4	45-3/4	47-3/4	50	45-1/2	47-1/2	49-1/2	53-7/8
46	46	47	49	50-3/4	45-3/4	47-3/4	49-3/4	52-1/4	48	50	52	56-1/2
48	47-1/2	49	51	53	48	50	52	54-3/4	50	52	54	58-1/2
50	49-1/2	51	53	55-1/4	50	52	54	57	-	-	-	-
52	51-1/2	53	55	57-1/4	52	54	56	59	-	-	-	-
54	53-1/4	55-1/4	57-1/4	59-3/8	54-1/4	56-1/4	58-1/4	61-1/4	-	-	-	-
56	55-1/4	57-1/4	59-1/4	61-3/4	56-1/4	58-1/4	60-1/4	63-1/2	-	-	-	-
58	57-1/4	59-3/4	61-1/4	63-3/4	58	60-1/2	62-1/2	65-1/2	-	-	-	-
60	59-3/4	61-3/4	63-3/4	66-1/4	60-1/4	62-3/4	64-3/4	68-1/4	-	-	-	-



Series A Flanges 22" and Over

Nom. Pipe Size	Class 150				Class 300				Class 400			
	Inner Ring I.D.	Sealing Element I.D.	Sealing Element O.D.	Centering Ring O.D.	Inner Ring I.D.	Sealing Element I.D.	Sealing Element O.D.	Centering Ring O.D.	Inner Ring I.D.	Sealing Element I.D.	Sealing Element O.D.	Centering Ring O.D.
22	-	22-3/4	24	26	-	22-3/4	24-3/4	27-3/4	-	22-3/4	24-3/4	27-5/8
26	25-3/4	26-1/2	27-3/4	30-1/2	25-3/4	27	29	32-7/8	26	27	29	32-3/4
28	27-3/4	28-1/2	29-3/4	32-3/4	27-3/4	29	31	35-3/8	28	29	31	35-1/8
30	29-3/4	30-1/2	31-3/4	34-3/4	29-3/4	31-1/4	33-1/4	37-1/2	29-3/4	31-1/4	33-1/4	37-1/4
32	31-3/4	32-1/2	33-7/8	37	31-3/4	33-1/2	35-1/2	39-5/8	32	33-1/2	35-1/2	39-1/2
34	33-3/4	34-1/2	35-7/8	39	33-3/4	35-1/2	37-1/2	41-5/8	34	35-1/2	37-1/2	41-1/2
36	35-3/4	36-1/2	38-1/8	41-1/4	35-3/4	37-5/8	39-5/8	44	36-1/8	37-5/8	39-5/8	44
38	37-3/4	38-1/2	40-1/8	43-3/4	37-1/2	38-1/2	40	41-1/2	37-1/2	38-1/4	40-1/4	42-1/4
40	39-3/4	40-1/2	42-1/8	45-3/4	39-1/2	40-1/4	42-1/8	43-7/8	39-3/8	40-3/8	42-3/8	44-3/8
42	41-3/4	42-1/2	44-1/4	48	41-1/2	42-1/4	44-1/8	45-7/8	41-3/8	42-3/8	44-3/8	46-3/8
44	43-3/4	44-1/2	46-3/8	50-1/4	43-1/2	44-1/2	46-1/2	48	43-1/2	44-1/2	46-1/2	48-1/2
46	45-3/4	46-1/2	48-3/8	52-1/4	45-3/8	46-3/8	48-3/8	50-1/8	46	47	49	50-3/4
48	47-3/4	48-1/2	50-3/8	54-1/2	47-5/8	48-5/8	50-5/8	52-1/8	47-1/2	49	51	53
50	49-3/4	50-1/2	52-1/2	56-1/2	49	51	53	54-1/4	49-1/2	51	53	55-1/4
52	51-3/4	52-1/2	54-1/2	58-3/8	52	53	55	56-1/4	51-1/2	53	55	57-1/4
54	53-1/2	54-1/2	56-1/2	61	53-1/4	55-1/4	57-1/4	58-3/4	53-1/4	55-1/4	57-1/4	59-3/4
56	55-1/2	56-1/2	58-1/2	63-1/4	55-1/4	57-1/4	59-1/4	60-3/4	55-1/4	57-1/4	59-1/4	61-3/4
58	57-1/2	58-1/2	60-1/2	65-1/2	57	59-1/2	61-1/2	62-3/4	57-1/4	59-1/4	61-1/4	63-3/4
60	59-1/2	60-1/2	62-1/2	67-1/2	60	61-1/2	63-1/2	64-3/4	59-3/4	61-3/4	63-3/4	66-1/4

Nom. Pipe Size	Class 600				Class 900			
	Inner Ring I.D.	Sealing Element I.D.	Sealing Element O.D.	Centering Ring O.D.	Inner Ring I.D.	Sealing Element I.D.	Sealing Element O.D.	Centering Ring O.D.
22	-	22-3/4	24-3/4	28-7/8	-	-	-	-
26	25-1/2	27	29	34-1/8	26	27	29	34-3/4
28	27-1/2	29	31	36	28	29	31	37-1/4
30	29-3/4	31-1/4	33-1/4	38-1/4	30-1/4	31-1/4	33-1/4	39-3/4
32	32	33-1/2	35-1/2	40-1/4	32	33-1/2	35-1/2	42-1/4
34	34	35-1/2	37-1/2	42-1/4	34	35-1/2	37-1/2	44-3/4
36	36-1/8	37-5/8	39-5/8	44-1/2	36-1/4	37-3/4	39-3/4	47-1/4
38	37-1/2	39	41	43-1/2	39-3/4	40-3/4	42-3/4	47-1/4
40	39-3/4	41-1/4	43-1/4	45-1/2	41-3/4	43-1/4	45-1/4	49-1/4
42	42	43-1/2	45-1/2	48	43-3/4	45-1/4	47-1/2	51-1/4
44	43-3/4	45-3/4	47-3/4	50	45-1/2	47-1/2	49-1/2	53-7/8
46	45-3/4	47-3/4	49-3/4	52-1/4	48	50	52	56-1/2
48	48	50	52	54-3/4	50	52	54	58-1/2
50	50	52	54	57	-	-	-	-
52	52	54	56	59	-	-	-	-
54	54-1/4	56-1/4	58-1/4	61 1/4	-	-	-	-
56	56-1/4	58-1/4	60-1/4	63-1/2	-	-	-	-
58	58	60-1/2	62-1/2	65-1/2	-	-	-	-
60	60-1/4	62-3/4	64-3/4	68-1/4	-	-	-	-

